

COLLECTORS NO. 40024



Chippendale Lowboy
Circa 1725

Chippendale designed many variations of the lowboy. His simplest ones, other than the use of the ball-and-claw feet on the cabriole legs, differed only slightly from the designs of the Queen Anne period. His richest ones, however, were probably some of the finest ever made.

They were, almost without exception, made of mahogany and were distinguished by the use of the ball-and-claw feet on the cabriole legs and by quarter columns at the front corners. The lowboys always had four drawers, one long shallow drawer across the top and three deeper drawers across the bottom.

The center drawer on the bottom was sometimes deeper than the two adjacent drawers and was always the focus of attention of the entire piece due to the carving on its front.

The lowboy served several purposes in the colonial home, the most common of which was as a dressing table for the lady of the house. During the day it also sometimes served as her writing table. Its usefulness, however, wasn't limited to the bedroom and one could find it used in reception, main halls, parlors, etc.

The elegance of the design of these pieces caught the eye wherever they were used and in today's homes their elegance, and utility, still makes them a highly desirable and prized possession.



AUTHENTIC REPRODUCTIONS IN MINIATURE

The CRAFTMARK® House of Miniature Collectors Series of furniture and accessories have all been carefully researched by specialists through major museum and library collections to assure the highest quality of authenticity in reproduction. Details are extraordinarily accurate to satisfy the most discriminating miniaturist.

All wood parts are machined to assure accurate and precise acceptance of each piece by another.

For a complete catalog of the CRAFTMARK HOUSE OF MINIATURES furniture line and accessories, write to:

THE HOUSE OF
MINIATURES
Customer Service-Catalog Dept.
147 Lake Street
Delaware, OH 43015

Please include \$2.00 for
Postage & Handling.

INTRODUCTION

BEFORE STARTING

Identify and account for each part by placing it on the Layout Sheet (make sure the correct layout sheet is used when working on multi-kit Instruction Sheets). Should any parts be missing, send a post card to:

THE HOUSE OF MINIATURES
Customer Service - Parts Dept.
147 Lake Street
Delaware, OH 43015

Please print Name, Address, Part Number (Number from Layout Sheet) and Kit Name and Number on card when ordering.

SANDING

Before assembly, sand all the outer surfaces of individual parts with 220 grit sandpaper, or finer, sanded in the same direction as the wood grain until the surface is smooth. Take care not to round any edges or corners of the pieces. Finish sanding with 280 grit sandpaper.

PRE-ASSEMBLY

A. After sanding, check the proper location and fit of each part by assembling parts loosely, without gluing. Use the **DETAIL VIEWS** as a guide.

B. All parts for CRAFTMARK kits are made on precision milling machines. When adjustments are required, sand to fit.

TOOLS AND MATERIALS

- A. The following tools will be helpful in constructing this kit:
1. Knife
 2. Tweezer
 3. Two-inch Sander
 4. Large Clamp
 5. Small Clamp
 6. CRAFTMARK Professional Finishing Kit (or equivalent, see note)
- B. The following materials will be needed to construct this kit:
1. CRAFTMARK Tinted Glue (see note)
 2. Waxed paper
 3. Sandpaper-220 and 280 grit
 4. Steel Wool-Grade 0000
 5. White glue (or equivalent)
 6. Small Artist's Brush

NOTE: The CRAFTMARK tinted glue is matched to the finish used in the Professional Finishing Kit. This will produce the authentic finish of the period in which the original Furniture was produced. When not using our glue follow manufacturer's directions.

GLUING

- A. Glue should be applied in small amounts to surface being joined. When gluing dado joints apply glue to dado only.
- B. To ensure a tight fit, squeeze excess glue out of the joints. Hold glued parts together with clamps, rubber bands or weights on the parts.
- C. Wipe off excess glue promptly.
- D. Be sure a glued assembly has dried thoroughly before adding parts.

FINISHING

The CRAFTMARK Professional Finishing Kit enables you to finish your furniture by the same process used by the professional furniture maker. The end result is what is important—there are easier methods, but none that will give the quality results that this process will, if you use a finish other than CRAFTMARK'S refer to the manufacturer's directions.

Detail Views

KIT 40024

Layout Sheet

Parts for Steps 1 thru 3

58 (2 REQ'D)

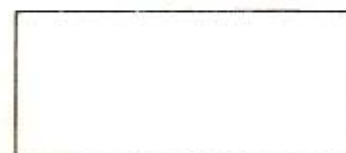

57 (2 REQ'D)

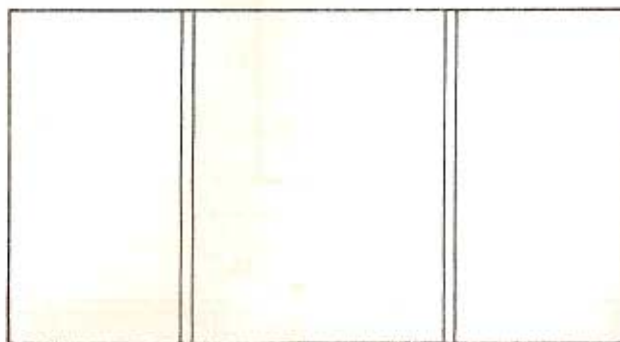

56

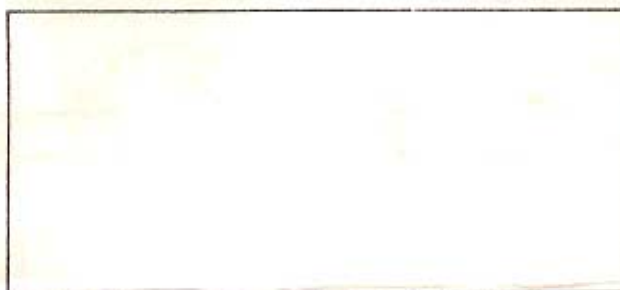

53



89

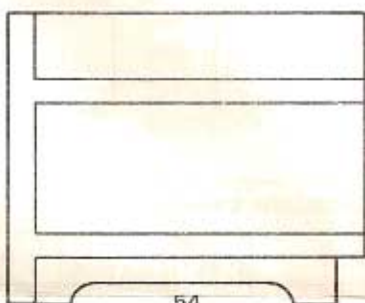

54

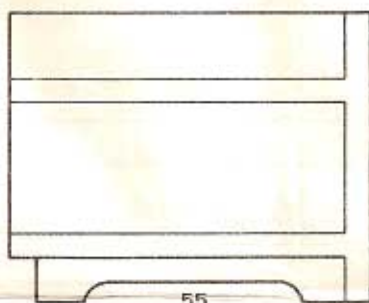

55

Step 1

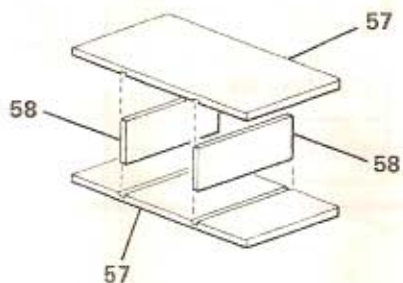

NOTE: Make certain that parts (57) and (58) are flush at front edge.

A. Glue vertical drawer dividers (58) into dados in horizontal drawer dividers (57).

Step 2

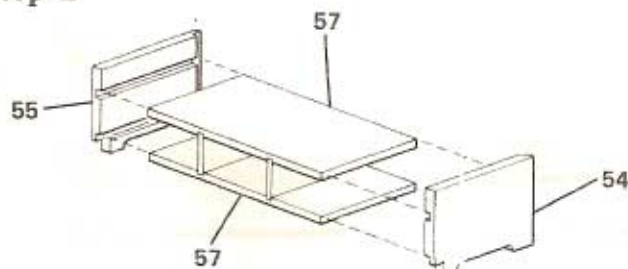

NOTE: Make certain parts (54) and (55) are flush with front edge of horizontal dividers (57).

A. Glue horizontal dividers (57) into dados of parts (54) and (55).

Step 3

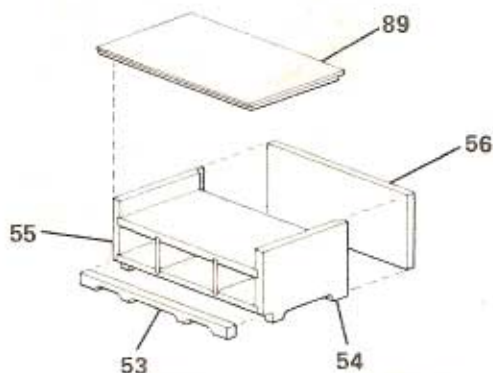

NOTE: Make certain back (56) is flush with top and bottom edges of parts (54) and (55). All parts must be squared.

B. Glue top (2) to top edges of parts (54), (55) and (97). Center with back flush.

A. Glue back (56) into rabbets on side pieces (54) and (55).

C. Glue base front (53) to notches in parts (54) and (55).

Detail Views

KIT 40024

Layout Sheet

Parts for Steps 4 thru 6

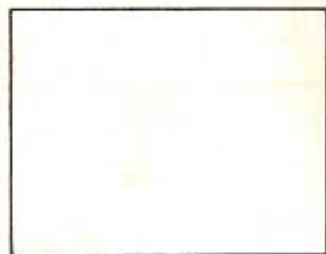

21



6
(4 REQ'D)

8
(2 REQ'D)

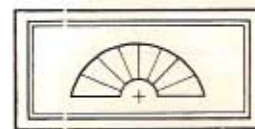

22

87 (6 REQ'D)

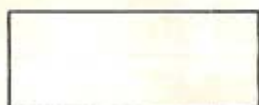
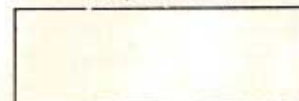

71

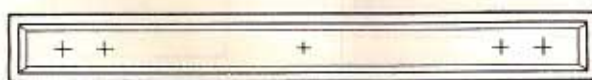

81

85 (2 REQ'D)

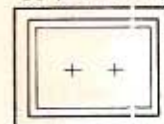

86 (2 REQ'D)



83 (2 REQ'D)

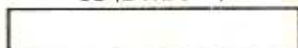

82

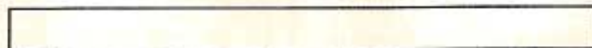

84

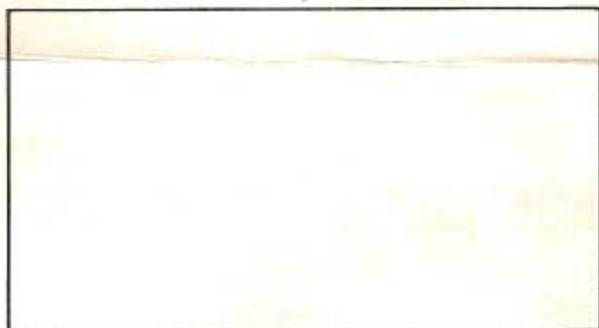

88
(2 REQ'D)



HARDWARE CHECK LIST

DESCRIPTION	VISUAL IDENTIFICATION	QTY
KNOB		1
ESCUTCHEON		4
BAIL		4
ESCUTCHEON		1
KEY PLATE		1

Step 4

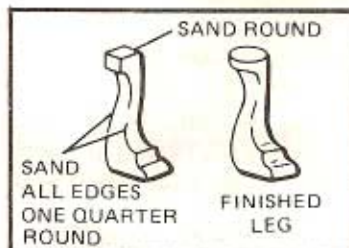

NOTE: Legs may be shaped prior to assembly by sanding as shown.

NOTE: Turn assembly upside down.

- Center and glue finials (8) to projections on base front (53).
- Glue legs (6) to assembly keeping outer edges flush with the assembly.

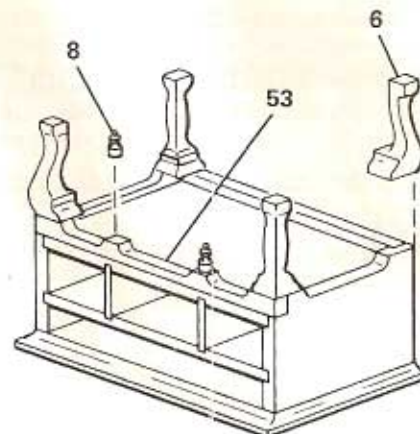

Detail Views

KIT 40024

Step 5

NOTE: Use white glue for assembly of drawer, if inside is not going to be stained.

A. Mark position of escutcheons on drawer fronts (22), (81) and (85) with pin using layout sheet as a guide.

B. Drill through holes as marked using a 65 drill bit.

NOTE: Refer to Final Finishing for assembly and drawer fronts.

C. Glue sides to bottom making certain they are flush with front edges.

D. Glue back to bottom and against rear edge of sides.

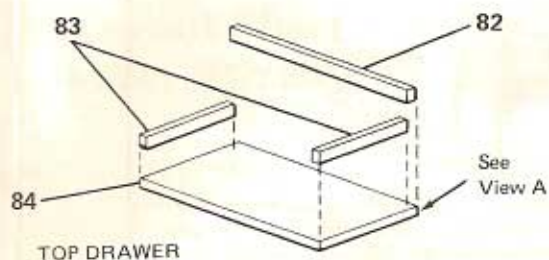

TOP DRAWER

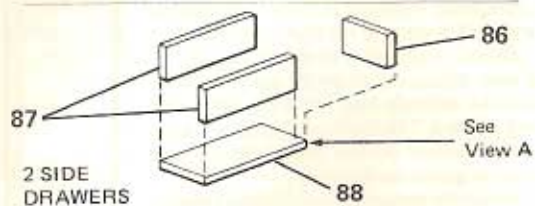

2 SIDE DRAWERS

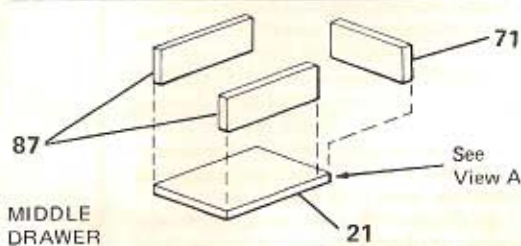

MIDDLE DRAWER

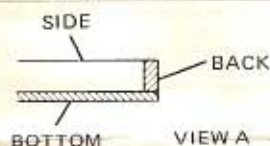

Step 6

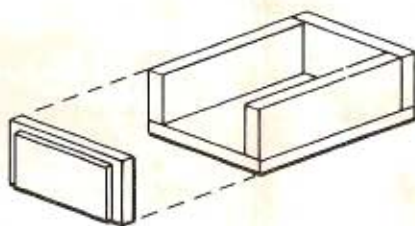

NOTE: Drawer fronts and hardware are installed after all Final Finishing steps are complete.

A. Glue front of each drawer to front edges of sides and bottom.

B. (Top Drawer only) apply a small amount of white glue to the back of key plate and glue to center of drawer front.

C. (Top and 2 Side Drawers) Pass handle through escutcheon and apply a small amount of white glue to back of plate.

D. Install bail through holes in drawer front.

E. Bend up protruding ends and bend down front of bail.

F. (Middle Drawer only) apply a small amount of white glue to round escutcheon and glue to drawer front. Insert knob (brad).

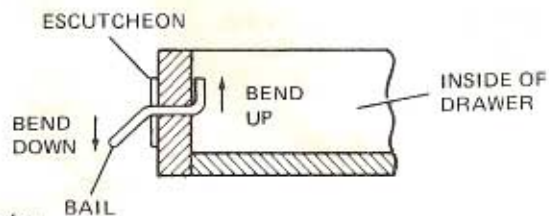

CROSS-SECTION OF TOP AND 2 SIDE DRAWERS