

COLLECTORS NO. 40028



Straight Leg
Chippendale Chair
Circa 1770

The straight leg chair was somewhat of a departure from Chippendale style, or at least the style most commonly identified with Chippendale. The absence of the cabriole leg and the ball-and-claw foot sometimes leads to the lack of recognition of his touch in this style of chair. In reality many of Chippendale's furniture designs featured straight legs, block feet, and bracket feet on his chairs, beds, and chests respectively.

The straight legs were seldom rounded except perhaps slightly on the front and rear edges. The stretchers were relatively thin, but added considerable strength to the chair since they were always dovetailed into the legs and the median stretcher was dovetailed into the side stretchers.

The overall design, of the straight leg chair, showed little variance, other than the presence of stretcher, from the cabriole leg chair until later in the Chippendale period when his designs exhibited a strong Chinese influence.

Chairs of this type were most commonly found in the dining room but were also utilized in many rooms of the home, at desks, writing tables, or in hallways. The elegance of their rich carving and beautiful upholstery were appreciated wherever they were used.

ASSEMBLY AND FINISHING INSTRUCTIONS



AUTHENTIC REPRODUCTIONS IN MINIATURE

The X-ACTO® House of Miniatures Collectors Series® of furniture and accessories have all been carefully researched by specialists through major museum and library collections to assure the highest quality of authenticity in reproduction. Details are extraordinarily accurate to satisfy the most discriminating miniaturist.

All wood parts are machined to assure accurate and precise acceptance of each piece by another.

For a complete catalog of the X-ACTO® HOUSE OF MINIATURES furniture line and accessories, write to:

X-ACTO® THE HOUSE OF MINIATURES Dept. KIT
45-35 Van Dam Street
Long Island City,
New York 11101

Please include \$2.00 for postage and handling.

INTRODUCTION

BEFORE STARTING

Identify and account for each part by placing it on the Layout Sheet (make sure the correct layout sheet is used when working on multi-kit Instruction Sheets). Should any parts be missing, send a post card to:

X-ACTO/The House of Miniatures
45-35 Van Dam Street
Long Island City, N.Y. 11101

Please print Name, Address, Part Number (Number from Layout Sheet) and Kit Name and Number on card when ordering.

SANDING

Before assembly, sand all the outer surfaces of individual parts with 220 grit sandpaper, or finer, sanded in the same direction as the wood grain until the surface is smooth. Take care not to round any edges or corners of the pieces. Finish sanding with 280 grit sandpaper.

PRE-ASSEMBLY

A. After sanding, check the proper location and fit of each part by assembling parts loosely, without gluing. Use the **DETAIL VIEWS** as a guide.

B. All parts for X-ACTO kits are made on precision milling machines. When adjustments are required, sand to fit.

TOOLS AND MATERIALS

A. The following tools will be helpful in constructing this kit:

1. Knife, X-ACTO No. 1, with Blade No. 11
2. Tweezer, X-ACTO No. 7336
3. Two-inch Sander, X-ACTO No. 7042
4. Large Clamp, X-ACTO No. 7004
5. Small Clamp, X-ACTO No. 7003
6. X-ACTO Professional Finishing Kit (or equivalent, see note)

B. The following materials will be needed to construct this kit:

1. X-ACTO Tinted Glue (see note)
2. Waxed paper
3. Sandpaper - 220 and 400 grit
4. Steel Wool - Grade 0000
5. White glue (or equivalent)
6. Small Artist's Brush

NOTE: The X-ACTO tinted glue is matched to the finish used in the Professional Finishing Kit. This will produce the authentic finish of the period in which the original Furniture was produced. When not using X-ACTO glue follow manufacturer's directions.

GLUING

A. Glue should be applied in small amounts to surface being joined. When gluing dado joints apply glue to dado only.

B. To ensure a tight fit, squeeze excess glue out of the joints. Hold glued parts together with clamps, rubber bands or weights on the parts.

C. Wipe off excess glue promptly.

D. Be sure a glued assembly has dried thoroughly before adding parts.

FINISHING

The X-ACTO Professional Finishing Kit enables you to finish your furniture by the same process used by the professional furniture maker. The end result is what is important — there are easier methods, but none that will give the quality results that this process will. If you use a finish other than X-ACTO's, refer to the manufacturer's directions.

Detail Views

KIT 40028

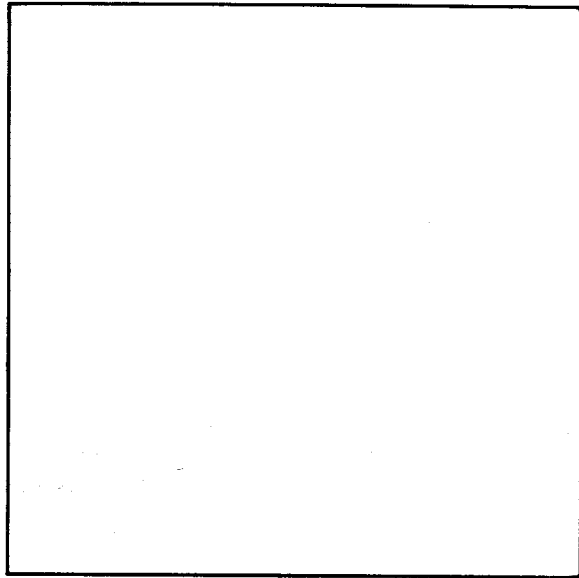

15
(MATERIAL)
(2 REQ'D)

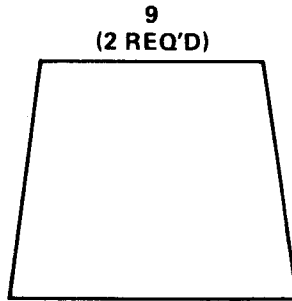

9
(2 REQ'D)
CARDBOARD

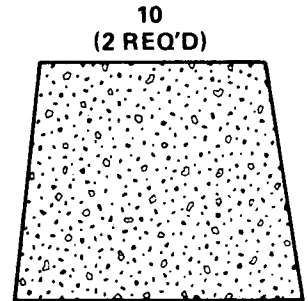

10
(2 REQ'D)
FOAM

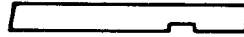

29 (4 REQ'D)

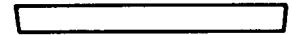

28 (2 REQ'D)



30 (4 REQ'D)

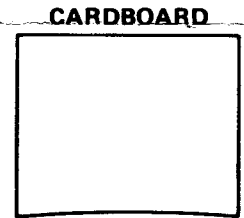

18

Layout Sheet

(for Steps 4 thru 7)

Step 4

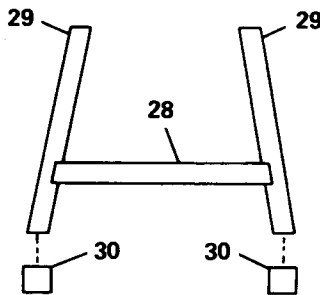

A. Glue front brace (28) to notches in side braces (29).

B. Glue front legs (30) to side braces (29).

Step 5

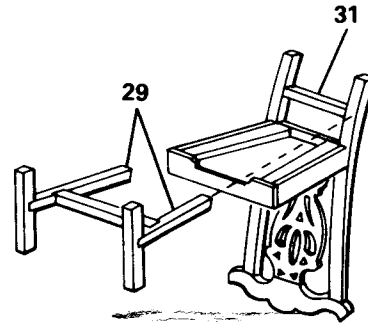

A. Glue leg assembly to chair bottom, aligning side braces (29) with rear brace (31).

Step 6

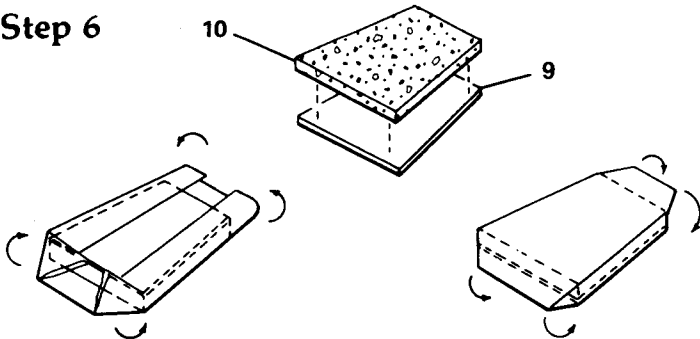

A. Glue cushion (10) to base (9) with white glue.

B. Place cushion (10) down on material (15). Fold material over and glue in place.

C. Tuck each corner under.

D. Fold front and rear of fabric and glue in place.

Detail Views

KIT 40028

Step 7

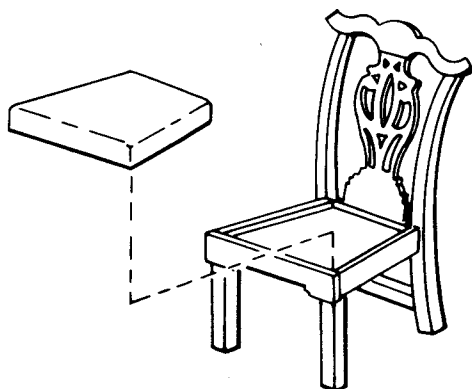

A. After Final Finishing of chair glue cushion to seat.

Alignment Patterns

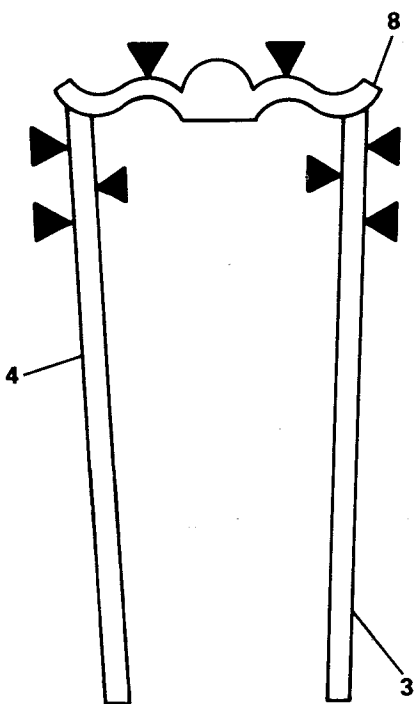

PATTERN NO. 1

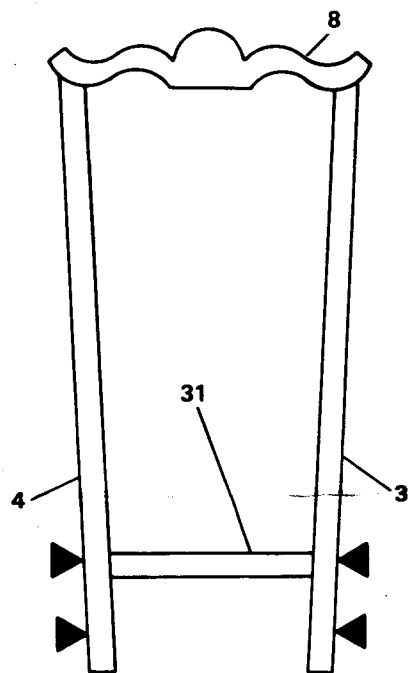

PATTERN NO. 2

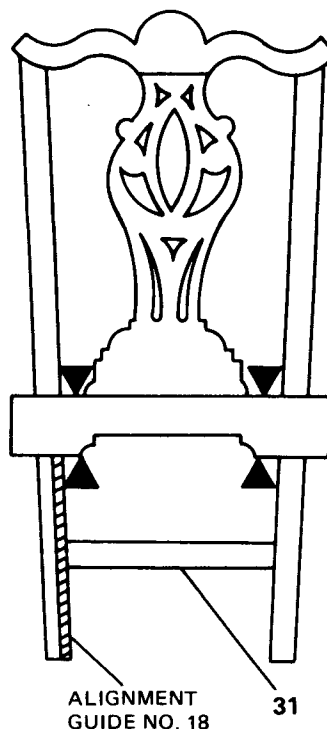

PATTERN NO. 3

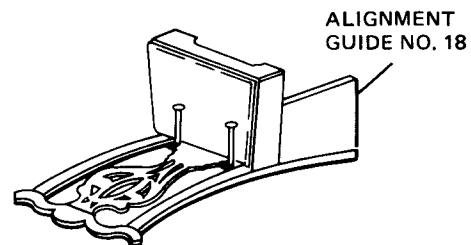
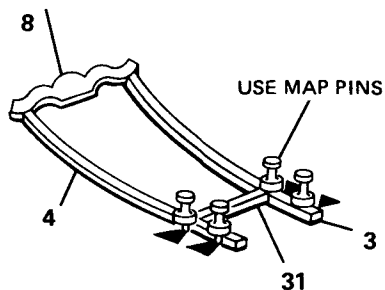
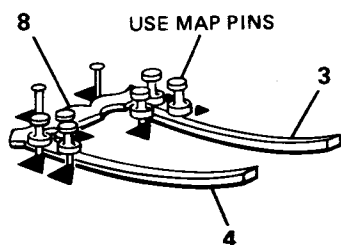

Detail Views

KIT 40028

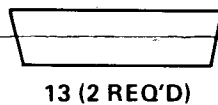
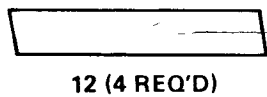
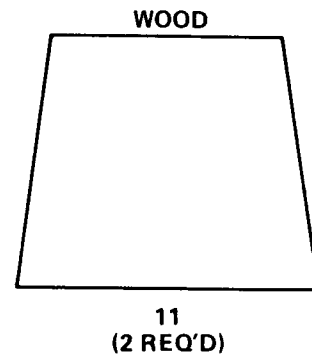
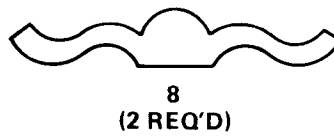
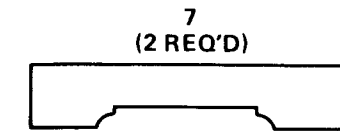
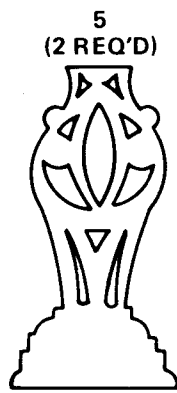
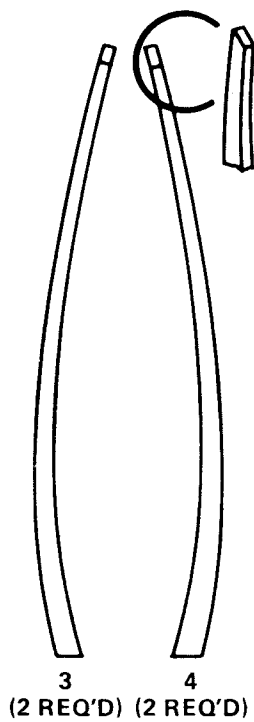

Layout Sheet (for Steps 1 thru 3)

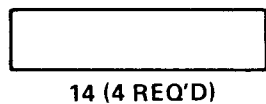

NOTE: Quantities shown on this Layout Sheet are for two chairs.

Step 1

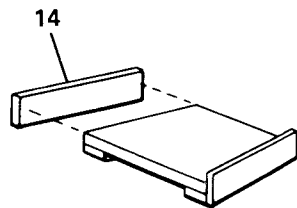
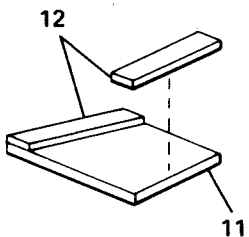

A. Glue bottom braces 12 to seat bottom (11).

B. Turn assembly over and glue seat sides (14) to seat bottom keeping front, rear and bottom edges flush.

Step 2

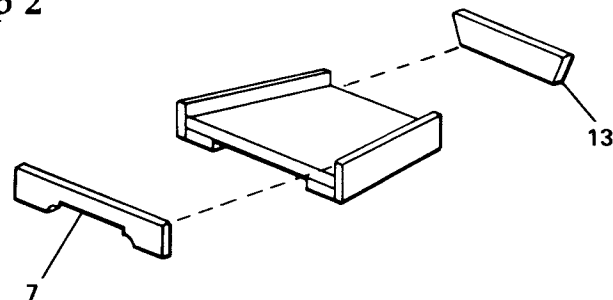

A. Glue seat front (7) to seat bottom keeping bottom and side edges flush.

B. Center and glue seat back (13) to seat bottom keeping bottom edge flush.

NOTE: Notches formed at rear corners are to accommodate rear legs.

Step 3

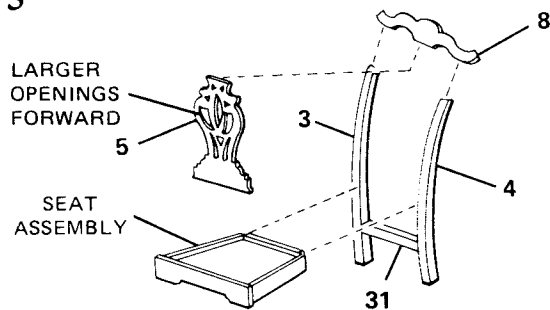

A. Utilizing Alignment Pattern No. 1, glue top rail (8) to left rear leg (4) and right rear leg (3).

B. Utilizing Alignment Pattern No. 2, glue rear brace (31) to rear legs (3) and (4).

C. Trim top and bottom edges of splat flush.

NOTE: Use alignment guide (18) for proper angle of seat assembly. Use splat (5) to determine location of seat.

D. Glue splat (5) to top rail (8) and seat assembly.