

COLLECTORS NO. 40031



Chippendale Bench
Circa 1760

There is a very small difference between this type of bench and what is commonly called the footstool. The primary difference is in the dimensions, since it was usually longer and slightly higher than a footstool and was used in place of a chair.

In the late 17th century there was seldom more than one chair in the house and that was reserved for the master of the house. The rest of the members of the household were relegated to benches, upholstered or hard wood depending upon their station.

Later in the 18th century this condition was reversed and the chair was no longer considered a seat of special honor. The progress of women's position in the household of the 18th century can almost be measured by this change. It is also due to this change that makes both the Chippendale and Queen Anne bench a rare find for today's antique collector.

Once the bench began to be replaced in daily usage, by the full backed chair, it was used primarily in the bedrooms and hallways of the Colonial home and seldom called upon to fill its original role except when company placed extreme demands on the home's seating capacity.

Most of these benches were completely upholstered or decorated with needlework. Leg styles ranged from the ornately carved cabriole to very plain straight legs.

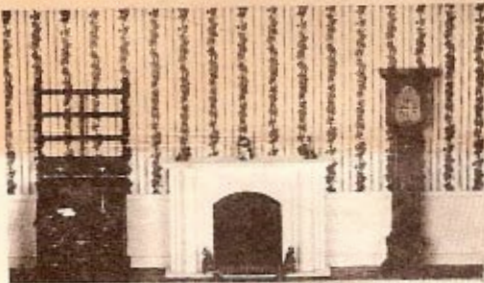

ASSEMBLY AND FINISHING INSTRUCTIONS



AUTHENTIC REPRODUCTIONS IN MINIATURE

The X-ACTO® House of Miniatures Collectors Series of furniture and accessories have all been carefully researched by specialists through major museum and library collections to assure the highest quality of authenticity in reproduction. Details are extraordinarily accurate to satisfy the most discriminating miniaturist.

Every item in the line is an authentic reproduction in miniature of regular-size furniture created by master craftsmen during the Colonial period, precision scaled, one inch to one foot.

All wood parts are machined to assure accurate and precise acceptance of each piece by another.

The rooms illustrated have been completed using standard X-ACTO® HOUSE OF MINIATURES products. All individual components are available.

For a complete catalog of the X-ACTO® HOUSE OF MINIATURES furniture line and accessories, write to:

X-ACTO/ THE HOUSE OF MINIATURES
Dept. KIT 45-35 Van Dam Street, Long Island
City, New York 11101.

Please include \$1.00 for postage and handling.

X-ACTO

INTRODUCTION

BEFORE STARTING

Identify and account for each part by placing it on the Layout Sheet (make sure the correct layout sheet is used when working on multi-kit Instruction Sheets). Should any parts be missing, send a post card to:

X-ACTO/The House of Miniatures
45-35 Van Dam Street
Long Island City, N.Y. 11101

Please print Name, Address, Part Number (Number from Layout Sheet) and Kit Name and Number on card when ordering.

SANDING

NOTE: When using sandpaper, remember that the higher the grit number, the finer the finish.

A. One sanding method that has proved successful is the use of a sanding platform. Tape a sheet of sandpaper of the proper grit size to a hard flat surface such as a table top or wood block. Press down lightly and move the piece to be sanded in the same direction as the wood grain until the surface is smooth. Take care not to round any edges or corners of the pieces.

B. Before assembly, sand all the outer surfaces of individual parts with 220 grit sandpaper, or finer. Finish sanding with 280 grit sandpaper or finer.

PRE-ASSEMBLY

A. After sanding, check the proper location and fit of each part by assembling parts loosely, without gluing. Use the **DETAIL VIEWS** as a guide.

B. All parts for X-ACTO kits are made on precision milling machines. When adjustments are required, sand to fit.

TOOLS AND MATERIALS

A. The following tools will be helpful in constructing this kit:

1. Knife, X-ACTO No. 1, with Blade, X-ACTO No. 11
2. Tweezer, X-ACTO No. 36
3. Two-inch Sander, X-ACTO No. 42
4. Large Clamp, X-ACTO No. 4004
5. Small Clamp, X-ACTO No. 4003
6. X-ACTO Professional Finishing Kit (or equivalent, see note)

B. The following materials will be needed to construct this kit:

1. X-ACTO Tinted Glue (see note)
2. Waxed paper
3. Sandpaper - 220 and 400 grit
4. Steel Wool - Grade 0000
5. White glue (or equivalent)
6. Small Artist's Brush

NOTE: The X-ACTO tinted glue is matched to the finish used in the Professional Finishing kit. This will produce the authentic finish of the period in which the original Furniture was produced. When not using X-Acto finishing kit follow Mfg Specs.

GLUING

A. Glue should be applied in small amounts to surface being joined. When gluing dado joints apply glue to dado only. On end cuts, it may be necessary to apply a second coat of glue before joining the parts.

B. To ensure a tight fit, squeeze excess glue out of the joints. Hold glued parts together with clamps, rubber bands or weights on the parts.

C. Wipe off excess glue promptly.

D. Be sure a glued assembly has dried thoroughly before adding parts.

Final Finishing for X-ACTO Professional Finishing Kit

The following process is the same method professional furniture makers use. The end result is what is important—there are easier

methods, but none that will give quality results that this process will.

NOTE: READ EACH STEP THOROUGHLY BEFORE PROCEEDING

A. Final Sanding. Lightly dry sand with (280) grit, garnet paper or finer, sanding with the grain. Your surface should, when finished, be very smooth.

B. Seal End and Edge Grains. Using the **Clear Finish/Sealer** as a sealer, apply a coat to all end grains with a small brush. Do NOT allow sealer to touch other surfaces.

DO NOT LOAD BRUSH WITH SEALER

Allow Drying Time - 12 Hours or more

C. Base Stain. Using the **BASE STAIN**, which is an oil base stain, apply a coat over the entire wood surface using a brush or cloth. **Immediately Wipe Off** all stain leaving an even color over the entire wood surface. This base color will be seen in the high-lighted area after the glaze stain has been applied.

NOTE: When finishing drawers - stain the face piece of the drawer only. This will add authenticity to your piece as regular-size furniture never has stained drawer interiors.

Allow Drying Time - 12-18 Hours

D. Sealing in Base Stain. In order to seal the base stain from subsequent coats that have the same solvent as the base stain, a sealer coat must be applied. Using the **Clear Finish/Sealer** apply a coat over the entire piece - using a brush or sprayer. Whichever method is used, be sure there are no drop marks. This should merely be a thin coat.

Allow Drying Time - 12 Hours or more

E. Glaze Stain. Apply the **Glaze Stain** with a brush, or rag, to the entire surface of your piece of furniture.

At this point you have a choice of achieving two types of finishes. Wiping the glaze stain off evenly until only a thin layer of color remains will produce an attractive finish with the tone you have selected.

Highlighting is a technique of light and dark areas that is accomplished by **Toning** or **Rubbing off the Glaze Stain** in areas exposing the base stain. With a soft cloth start blending tones of base stain and glaze stain by rubbing off the glaze stain starting from the middle of the piece and working outwards. The middle should be light with darker tones toward the outside edge.

THERE SHOULD NEVER BE A SHARP LINE OF DARK TO LIGHT COLOR - BUT RATHER A SMOOTH BLENDING EFFECT.

NOTE: If you are not satisfied with your first attempt in Highlighting, . . . merely wipe off the Glaze Stain from entire piece.

Allow Drying Time - 24 Hours

F. Final Finish or Top Coat. **After** the Glaze Stain has dried 24 hours, thoroughly wipe, **BRISKLY, BUT LIGHTLY**, the entire piece with a clean cloth.

Using the **Clear Finish/Sealer** apply an even coat over the entire surface of your piece of furniture with a soft brush, or sprayer.

Allow Drying Time - 12 Hours or more between each coat

Two or more coats of **Clear Finish** should be applied with 12 hours drying time between coats. . . after at least two coats have been applied a smoother finish may be attained by lightly buffing with No. 0000 steel wool. If additional coats of finish are applied, lightly buff between coats with No. 0000 steel wool.

NOTE: After each steel wool rubbing, make sure all steel wool "dust" is thoroughly removed.

(These instructions are for the Mahogany (P/N 43804), Walnut (P/N 43802), and Colonial (P/N 43803) Finishing Kits).

Layout Sheet

KIT 40031



25
MATERIAL



26
FOAM



17
CARDBOARD



27
WOOD

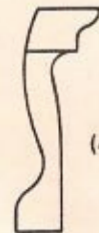

6
(4 REQ'D)

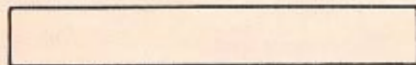

98
(2 REQ'D)

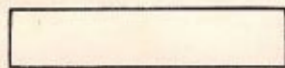

99
(2 REQ'D)

Step 1

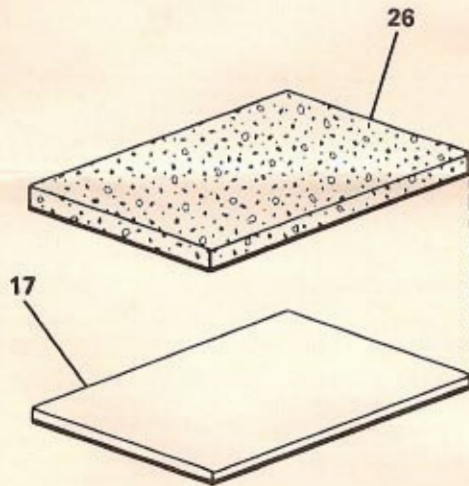

NOTE: Ensure all edges are properly aligned before glue sets.

A. Glue foam cushion (26) to cushion backing (17) with white glue.

Step 2

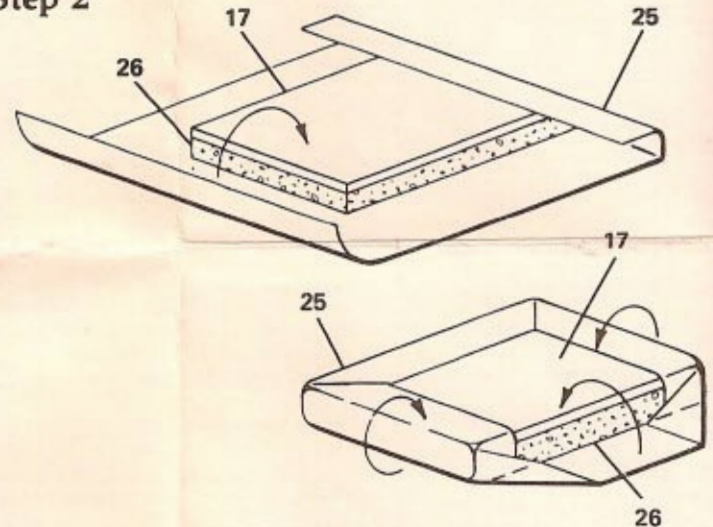

A. Place foam cushion (26) down on material (25). Spread glue across one end of cushion backing (17) and fold material up and glue in place.

B. Spread glue on opposite end of cushion backing (17) stretch

material smoothly over foam cushion (26) and fold end of material up and glue in place.

C. Fold corners so that there is a straight crease at each corner and glue material in place.

Detail Views

KIT 40031

Step 3

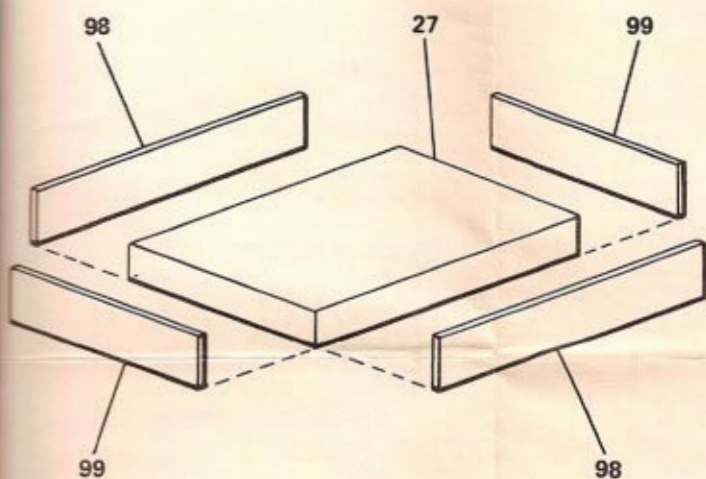

NOTE: Ensure all parts are flush at bottom.

A. Glue sides (99) to bench bottom (27).

B. Glue sides (98) to bench bottom (27).

Step 4

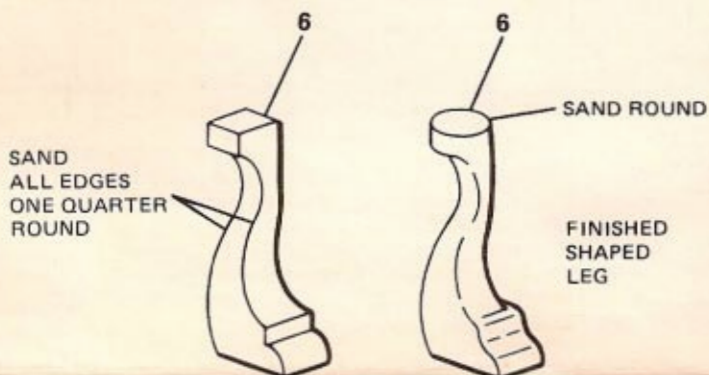

NOTE: Legs may be shaped prior to assembly.

A. Shape legs by sanding the edges.

B. Sand base of leg until it is round.

Step 5

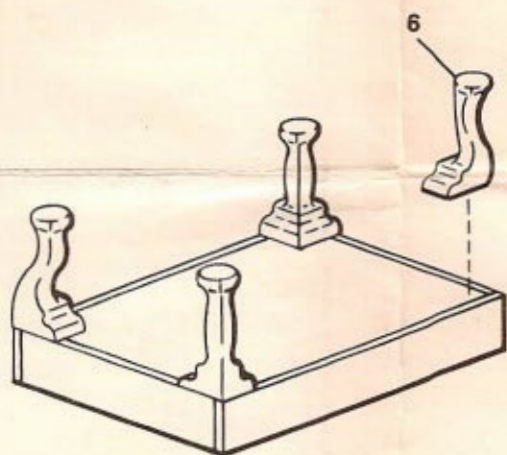

NOTE: Turn bench bottom up.

A. Glue legs (6) to bench bottom keeping outside edges of legs flush with assembly.

NOTE: Refer to Final Finishing.

Step 6



A. After Final Finishing, glue cushion in bench.