

COLLECTORS NO. 40050



Chippendale
Serpentine Chest

Circa 1760

Chippendale's case pieces reflected the same solid, yet graceful, appearance of the rest of his designs. This particular piece is actually a reverse-serpentine front since the mid-bow is in an outward direction.

The corners of the carcase were deeply chamfered without adornment. On some versions of this chest the chamfered edges were decorated with a deep-carved fretwork design, or boldly fluted.

Bases on pieces of this design were either unadorned or deeply molded, but most were built without an apron. The piece we have reproduced in miniature has heavily molded bracket feet, while other versions were supported on short protruding cabriole legs terminating in carved ball-and-claw feet.

The drawers were usually full width with graduated depths, but occasionally a chest was made with two half-width drawers at the top. The front treatment of the drawers varied with the whims of the cabinet-maker, or his customer. Some were faced with crotch-grained veneer, some were ornately carved, while others provided an expanse of warm-hued mahogany.

ASSEMBLY AND FINISHING INSTRUCTIONS



AUTHENTIC REPRODUCTIONS IN MINIATURE

The X-ACTO® House of Miniatures Collectors Series™ of furniture and accessories have all been carefully researched by specialists through major museum and library collections to assure the highest quality of authenticity in reproduction. Details are extraordinarily accurate to satisfy the most discriminating miniaturist.

All wood parts are machined to assure accurate and precise acceptance of each piece by another.

For a complete catalog of the X-ACTO® HOUSE OF MINIATURES furniture line and accessories, write to:

THE HOUSE OF MINIATURES
Customer Service - Catalog Dept.
80 Newbridge Road
Bergenfield, NJ 07621

INTRODUCTION

BEFORE STARTING

Identify and account for each part by placing it on the Layout Sheet (make sure the correct layout sheet is used when working on multi-kit Instruction Sheets). Should any parts be missing, send a post card to:

THE HOUSE OF MINIATURES
Customer Service - Parts Dept.
2000 Craftmark Center
Statesville, NC 28677-2000

Please print Name, Address, Part Number (Number from Layout Sheet) and Kit Name and Number on card when ordering.

SANDING

Before assembly, sand all the outer surfaces of individual parts with 220 grit sandpaper, or finer, sanded in the same direction as the wood grain until the surface is smooth. Take care not to round any edges or corners of the pieces. Finish sanding with 280 grit sandpaper.

PRE-ASSEMBLY

A. After sanding, check the proper location and fit of each part by assembling parts loosely, without gluing. Use the **DETAIL VIEWS** as a guide.

B. All parts for X-ACTO kits are made on precision milling machines. When adjustments are required, sand to fit.

TOOLS AND MATERIALS

A. The following tools will be helpful in constructing this kit:

1. Pin Vise X-ACTO No. 7144
2. Tweezer, X-ACTO No. 7336
3. Two-inch Sander, X-ACTO No. 7042
4. Large Clamp, X-ACTO No. 7004
5. Small Clamp, X-ACTO No. 7003
6. X-ACTO Professional Finishing Kit (or equivalent, see note)

B. The following materials will be needed to construct this kit:

1. X-ACTO Tinted Glue (see note)
2. Sandpaper - 220 and 280 grit
3. Steel Wool - Grade 0000
4. White glue (or equivalent)
5. Small Artist's Brush

NOTE: The X-ACTO tinted glue is matched to the finish used in the Professional Finishing Kit. This will produce the authentic finish of the period in which the original Furniture was produced. When not using X-ACTO glue follow manufacturer's directions.

GLUING

A. Glue should be applied in small amounts to surface being joined. When gluing dado joints apply glue to dado only.

B. To ensure a tight fit, squeeze excess glue out of the joints. Hold glued parts together with clamps, rubber bands or weights on the parts.

C. Wipe off excess glue promptly.

D. Be sure a glued assembly has dried thoroughly before adding parts.

FINISHING

The X-ACTO Professional Finishing Kit enables you to finish your furniture by the same process used by the professional furniture maker. The end result is what is important — there are easier methods, but none that will give the quality results that this process will. If you use a finish other than X-ACTO's, refer to the manufacturer's directions.

Layout Sheet

Kit 40050

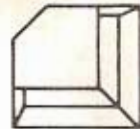
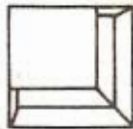
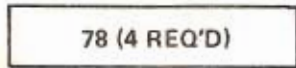
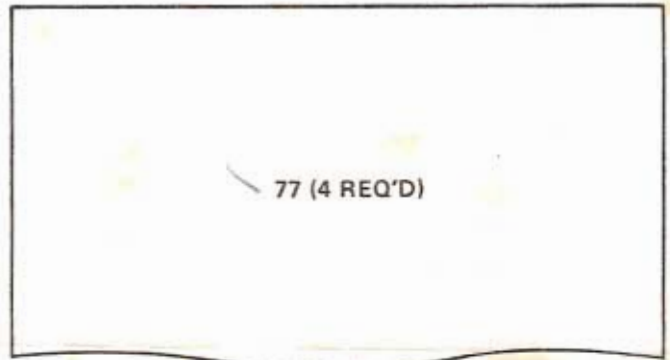
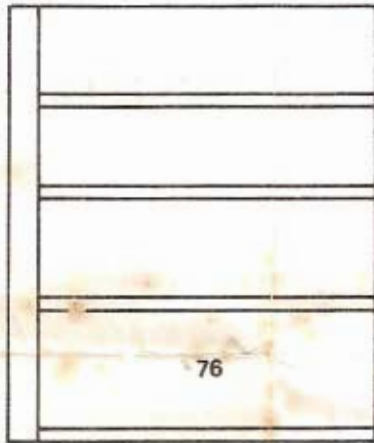
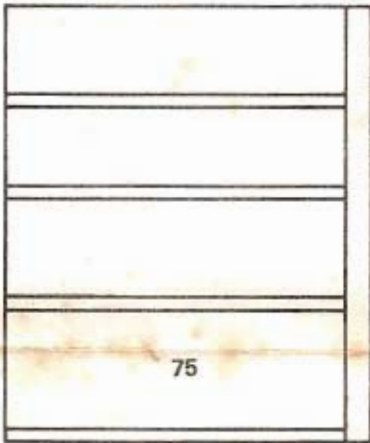
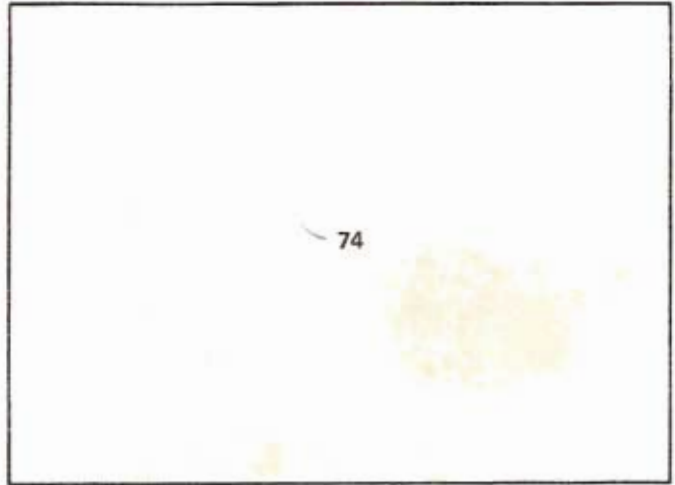
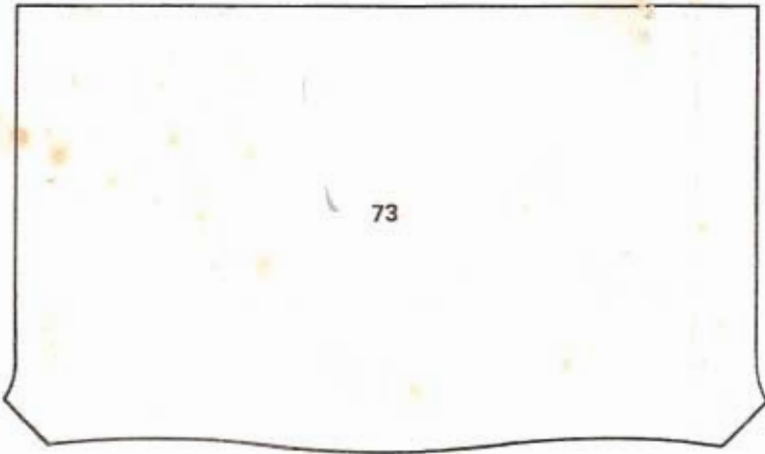

80 (2 REQ'D)

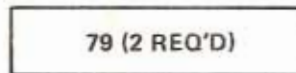

89 (2 REQ'D)

90 (2 REQ'D)

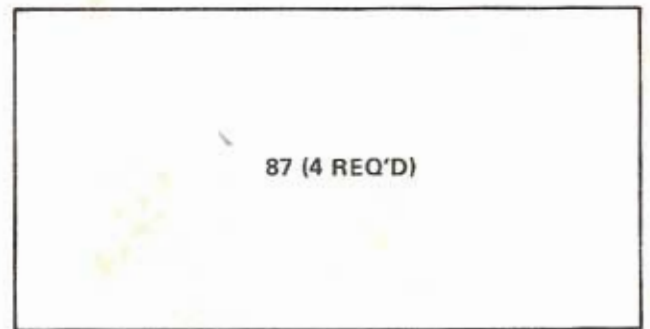
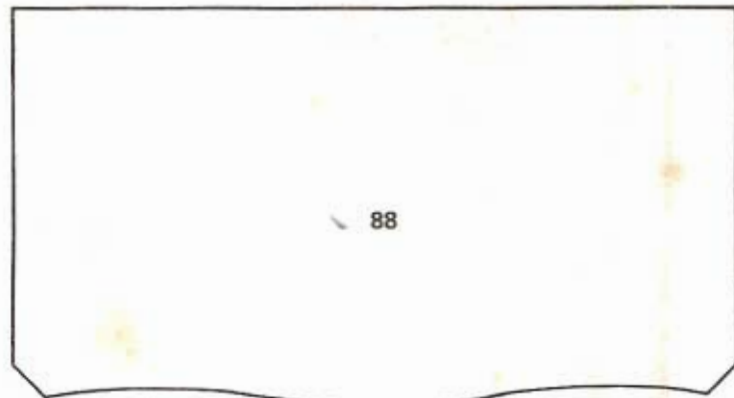
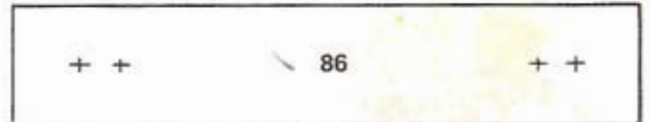
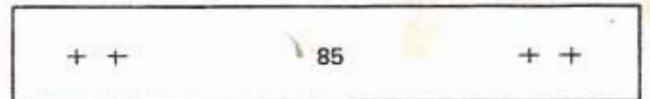
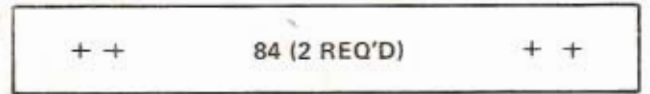
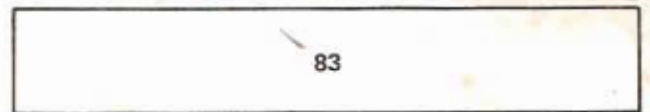
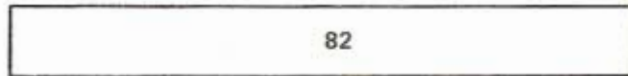
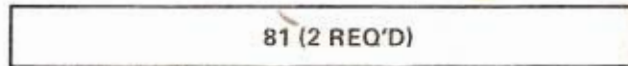
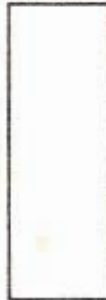

Detail Views

Kit 40050

Step 1

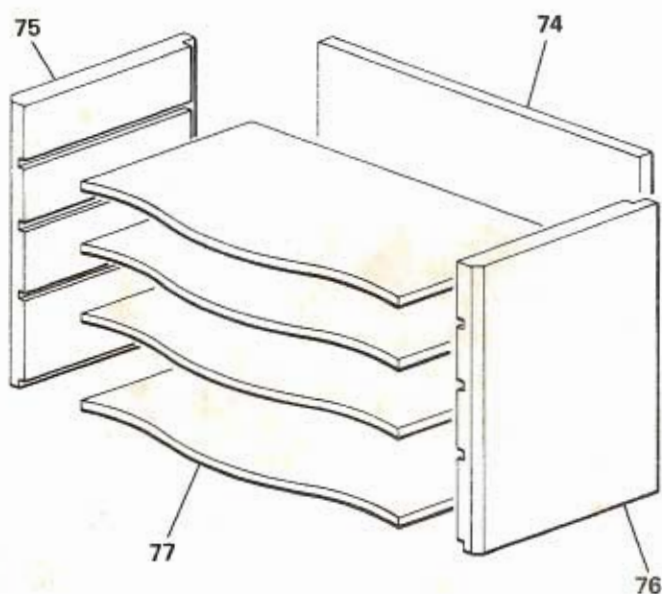

A. Glue dividers (77) into dadoes of sides (75) & (76). Rear edges should be flush with front edge of the rabbets at rear of side pieces. Do not sand off

any over hang in front at this point.
B. Glue back (74) into the rabbets of the side pieces and square entire assembly.

Step 2

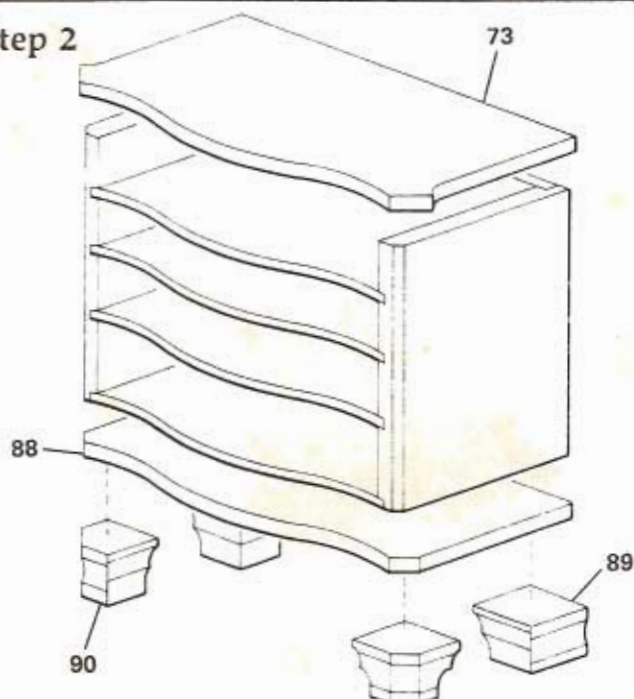

A. Glue top (73) to case assembly. It should be flush at the rear and centered.

B. Glue base (88) to the case assembly. It should be flush at the rear and centered.

C. Glue the bracket feet, (90) at front and (89) at the rear, at the corners of the base. After the glue has set sand the front legs slightly so that the blend with the curvature of the base.

Step 3

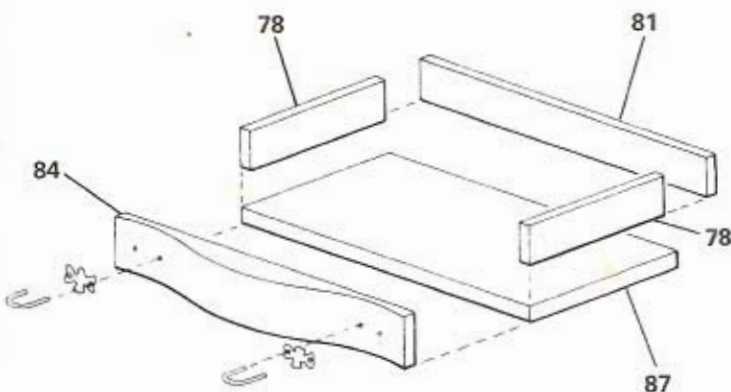

HARDWARE:

- 8 Small Chippendale Handles
- 8 Small Chippendale Plates

A. Glue the two sides (78) onto the base (87) so that they are flush with the front edge and ends.

B. Glue the back (81) against the ends of the sides (78) and onto the bottom (87).

C. If interior of drawers are not to be stained apply final finish to drawer front (84) before completing assembly.

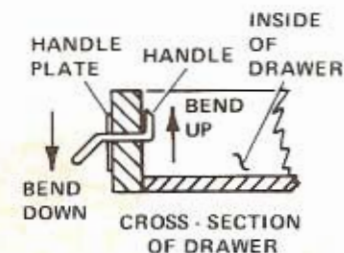

D. After final finishing install hardware as illustrated. A drop of white glue on the back of the plate will hold it in place.

Step 4

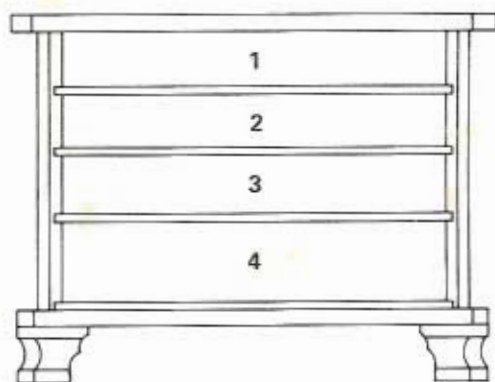

DRAWER	BOTTOM	SIDES	BACK	FRONT
1	87	78	81	84
2	87	78	81	84
3	87	79	82	85
4	87	80	83	86

A. Assemble remaining drawers using the chart as a guide to determine proper parts.

B. Insert all drawers into the

chest and sand if necessary to make drawer fronts and dividers flush. Pre-drill holes for hardware. See layout sheet for hole spacing.